

# Agilent PNA Microwave Network Analyzers

Application Note 1408-7

## Amplifier Linear and Gain Compression Measurements

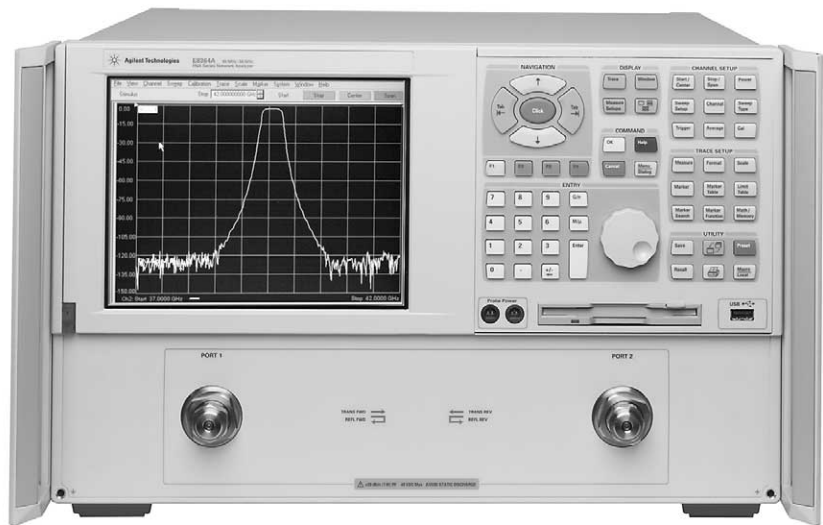

## Table of Contents

Introduction .....	2
Definitions .....	3
Transmission Measurements .....	4
Reflection Measurements .....	9
Gain Compression .....	10
Accuracy Considerations .....	15
References .....	15

## Introduction

This application note covers testing of an amplifier's linear S-parameters and gain compression using Agilent's microwave (MW) PNA Series of vector network analyzers. The MW PNA Series can also be used for testing amplifier nonlinear parameters such as harmonics and intermodulation distortion. Agilent Application Notes 1408-8 and 1408-9 cover the topics of harmonics and intermodulation distortion testing respectively.

Amplifiers are a fundamental building block of microwave systems, and characterizing the performance of amplifiers is a critical factor in the design process. Network analyzers are traditionally used for linear amplifier measurements, while spectrum analyzers are used for nonlinear measurements such as harmonics and intermodulation distortion. However, many of the modern network analyzers, including the Agilent MW PNA Series, can be used for nonlinear measurements as well, by enabling the frequency-offset functionality.

---

## Definitions

In this application note, the device under test (DUT) is an amplifier with the following specifications.

<b>Frequency range</b>	0.10 to 1000 MHz
<b>Minimum small signal gain</b>	20 dB
<b>Input SWR</b>	1.5:1
<b>Output SWR</b>	2.0:1
<b>Output 1 dB compression</b>	+3 dBm

---

### Note

MW PNA [front-panel keys] are shown in brackets, while the **softkeys** are displayed in bold; “menu item” refers to the Windows® drop down menus.

---

### Gain

Amplifier small signal gain is defined as the ratio of an amplifier’s output power delivered to a  $Z_0$  load to the input power delivered from a  $Z_0$  source, where  $Z_0$  is the characteristic impedance in which the amplifier is used (50 ohms in this note). In logarithmic terms, gain is the difference in dB between the output and input power levels at a particular frequency.

### Reverse isolation

Reverse isolation is a measure of transmission from output to input. The measurement of isolation is similar to the measurement of small signal gain, except that the stimulus is applied to the amplifier’s output.

### Deviation from linear phase

Ideally, the phase shift through an amplifier is a linear function of the frequency applied. The amount of variation from this theoretical phase shift is called deviation from linear phase or phase linearity.

### Group delay

Group delay is a measure of the transit time through an amplifier at a particular frequency. It is defined as the derivative of the phase response with respect to frequency. Similar to deviation from linear phase, it is a measure of amplifier distortion.

### Return loss/SWR

Return loss is a measure of the quality of the match of the input and output of the amplifier, relative to the system impedance. Reflection coefficient includes both magnitude and phase information of the reflected signals. Return loss and SWR are ways of examining the magnitude portion of the reflection coefficient.

### Gain compression

An amplifier has a region of linear gain, where the gain is independent of the power level. This gain is commonly referred to as small signal gain. As the input power is increased to a level that causes the amplifier to approach saturation, the gain will decrease, resulting in a large signal response. In this application note, the 1 dB gain compression is defined as the input power level where the amplifier gain drops 1 dB relative to the small signal gain.

---

## Transmission Measurements

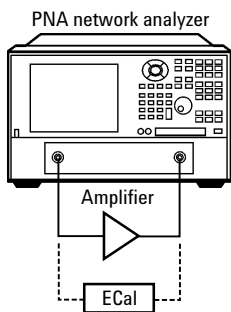

**Figure 1. Setup for testing transmission and reflection parameters.**

### Note

At preset, the source power level of the MW PNA Series network analyzer is set to  $-17$  dBm, with the internal source attenuator on port 1 set to 0 dB. If the amplifier under test could be damaged by this power level, or will be operating in its nonlinear region, do not connect the amplifier until you have set a desirable power level.

## Step 1: Setup

The first step of a transmission measurement is to set up the stimulus settings of frequency range, power level, number of points, and IF bandwidth.

### [Preset]

[Start/Center] > Start 0.1 [G/n] > Stop 1 [G/n]

[Power] > Level  $-20$  [Enter]

In addition to damage level, it is advisable to consider the compression level of the network analyzer. In the 0.1 to 1 GHz frequency range, the MW PNA receivers have 0.6 dB compression at +5 dBm test port input power.

Given our amplifier's gain of approximately 20 dB and input power level of  $-20$  dBm, the result will be a signal with roughly 0 dBm of power incident upon the test port. Therefore, we do not need to enable the receiver attenuators in this example. If necessary, the receiver attenuators can be enabled via the menu item **Channel, Power...**

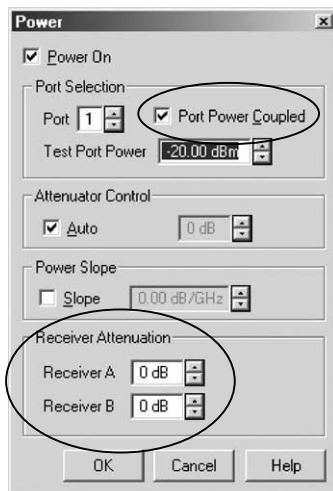

**Figure 2. MW PNA internal receiver attenuators make amplifier measurements easier by reducing the need for external attenuators.**

[Sweep Setup] > Points > 401 [Enter]

MW PNA Series allows the user to measure up to 16,001 points. If you have an amplifier with a wide frequency span, measure more points to get better frequency resolution. Alternatively, calibrate with many points over a wide frequency range. Then zoom in on a subset of the frequency range and still have excellent resolution and many calibrated points.

[Sweep setup] > Bandwidth

Verify that the network analyzer's IF bandwidth is set to the default 35 kHz. This is probably an adequate bandwidth for amplifier gain measurements, since a gain measurement does not require the maximum dynamic range, and you want to maximize measurement speed. If you have a high dynamic range filter connected to the amplifier as part of the DUT or would like to lower the system noise, reduce the bandwidth. MW PNA Series offers a range of IF bandwidths, from 1 Hz to 40 kHz.

### **High gain amplifier considerations**

When measuring high gain amplifiers, it is possible to damage the test port couplers, receivers, receiver attenuators, or source/splitter assembly. For the MW PNA, the damage levels are: +20 dBm at the test port (limited by the source/splitter assembly), +30 dBm for the couplers and bias-tees (if the source/splitter assembly is protected through source attenuation), +15 dBm for the receivers, and +30 dBm for the receiver attenuators. The MW PNA source attenuators (Option UNL) cover a 60 dB range, in 10 dB steps. The receiver attenuators (Option 016) cover a 35 dB range, in 5 dB steps.

If the amplifier output is connected to the test port input, do not apply more than +20 dBm to the test port input, since power levels higher than +20 dBm will damage the source/splitter assembly. If you have the source attenuator option, you can apply 10 dB or more of source attenuation, and then apply +20 dBm to the coupler input. You also have to protect the receiver, via the receiver attenuator. Though there is at least 14 dB of loss between the test port and the receiver, due to the coupler.

If the amplifier output is connected directly to the receiver input, via the front panel jumpers, then the signal is not incident upon the source/splitter assembly, and is directly incident upon the receiver or receiver attenuator. In such a case, the damage level is +15 dBm if the receiver attenuator is not used, and +30 dBm if the receiver attenuator is switched in. If you use the receiver attenuator, you can put in +30 dBm into the jumper input, apply 15 dB of attenuation, and make a valid measurement.

Please note that all of the power levels mentioned in Step 1 are damage levels. We recommend that you reduce the incident power upon the receivers well below the damage level, and even below the compression level, to obtain the most accurate measurements.

When measuring high gain amplifiers, it is recommended that you take advantage of the "Port Power Coupled" feature to uncouple the power of ports 1 and 2. Drive the input, or port 1, with a low power level as to not damage the output receivers. Drive the output, or port 2, with a high power level, so the isolation or  $S_{12}$  measurement does not approach the noise floor of the network analyzer. An accurate  $S_{12}$  measurement is fundamental to an accurate 2-port calibration.

---

---

## Step 2: Calibrate

A two-port calibration provides the maximum accuracy for this measurement. Agilent's electronic calibration (ECal) modules make the task of calibration much easier and less prone to user errors. You can learn more about ECal by visiting our website at [www.agilent.com/find/ecal](http://www.agilent.com/find/ecal).

### [Cal] > Cal Wizard

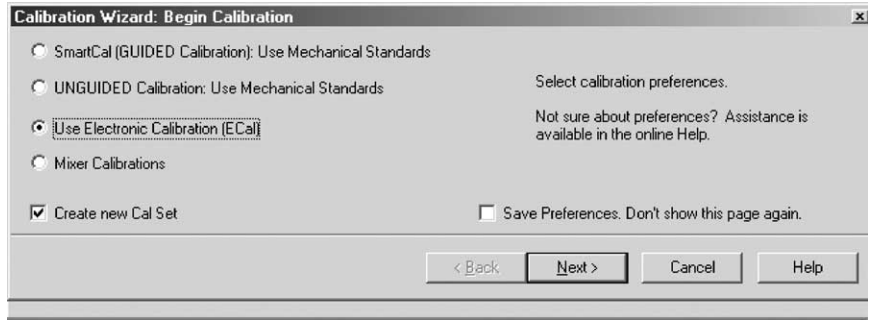

Figure 3. The MW PNA Calibration Wizard simplifies various calibration procedures.

Follow the recommended steps in Calibration Wizard. Save the instrument state with a pointer to the calibration set as a file "amplifier.cst."

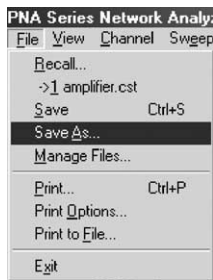

Figure 4. With the MW PNA's Windows 2000 operating system, file manipulation is as easy as it is on your personal computer.

Once the calibration has been completed, verify that it is active. Turn on the network analyzer **Status Bar** by selecting it under the menu item **View**, and verify that the calibration indicator "**C 2-P SOLT**" appears on the bottom of the screen.



Figure 5. The MW PNA status bar provides you with valuable information, including the calibration type and status.

---

---

## Step 3: Measure

Next connect the amplifier between port 1 and 2, and perform the measurements. Be sure to apply any appropriate biasing.

### Gain or $S_{21}$

Small signal gain is gain of the amplifier in its linear region of operation. This is typically measured at a constant input power over a swept frequency range.

[Measure] >  $S_{21}$

### Group delay

Group delay, like deviation from linear phase, is a measure of amplifier phase distortion. The MW PNA calculates group delay from the phase and frequency information and displays the results in real time. This measurement may require a specific group delay aperture. The minimum aperture is equal to the frequency span divided by the number of points minus one. Increasing the aperture reduces the group delay resolution, but lowers the trace noise.

### Deviation from linear phase

The deviation from linear phase measurement employs the electrical delay capability of the MW PNA to add electrical delay to the amplifier in order to remove the linear portion of the phase shift.

To view the gain in different formats, we can easily take advantage of the multi-parameter display capability of the MW PNA, by using a preconfigured setup. Configure window 2 for phase measurement, window 3 for group delay, and window 4 for deviation from linear phase.

[Measure Setups] > Setup B

Select window 2. [Measure] >  $S_{21}$  > [Format] > Phase

Select window 3. [Measure] >  $S_{21}$  > [Format] > Delay

Select window 4. [Measure] >  $S_{21}$  > [Format] > Phase

[Marker] > [Marker function] > >Delay

Place the marker in the center of the amplifier frequency span, and then activate the electrical delay function. By flattening the phase response, we have effectively removed the linear phase shift through the amplifier under test. The deviation from this linear phase shift remains.

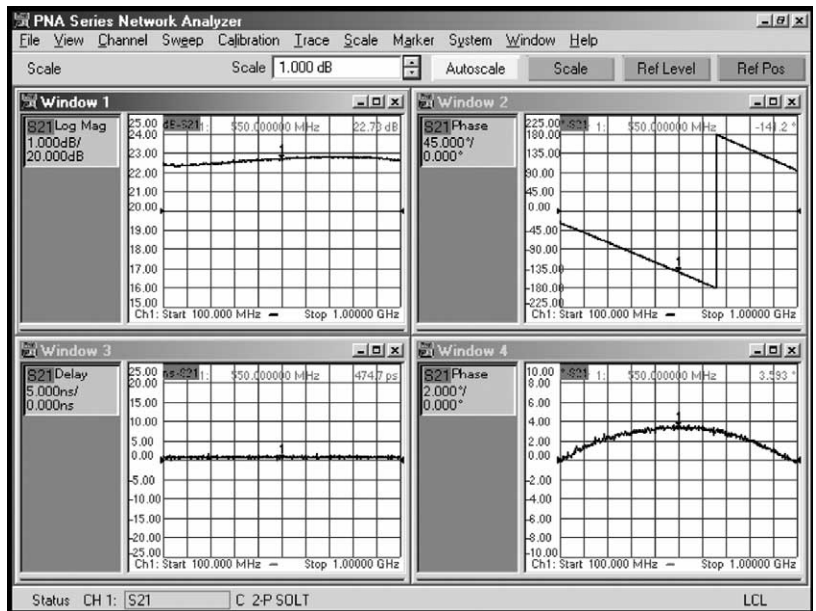

**Figure 6. View multiple amplifier parameters on one screen, using MW PNA's 4-parameter display capability.**

### Reverse isolation or $S_{12}$

For an isolation measurement, the stimulus is applied to port 2, or the output of the amplifier, and the signal level at port 1, or the input, is measured. For amplifiers with very high isolation, the noise floor of the MW PNA Series can be lowered by reducing the IF bandwidth.

At this point, you may want to recall the original instrument state to start with a clean trace, or you can remove the delay that was added in the previous step.

**[Recall] > ampl... cst**

**[Measure] > S12**



## Reflection Measurements

### Note

If the amplifier under test is operating in its nonlinear region, the large signal  $S_{22}$  should be measured using a load-pull technique. Traditional S-parameter measurements depend on the amplifier operating in its linear region.

## Step 1: Setup

Reflection measurement can be made using the same setup as transmission measurements.

## Step 2: Calibrate

Reflection measurement can be made using the same two-port calibration as transmission measurements.

## Step 3: Measure

### Input and output return loss – $S_{11}$ and $S_{22}$

Return loss and standing wave ratio (SWR) are commonly specified for the amplifier's input and output ports. With the MW PNA Series, you can view the reflection parameters in return loss or SWR format.

First set up an  $S_{11}$  trace and then add an  $S_{22}$  trace to the current display.

menu item **Trace > [Measure] > S11 > [Format] > [Format] > SWR**

menu item **Trace > New**

Select second trace **[Measure] > S22**

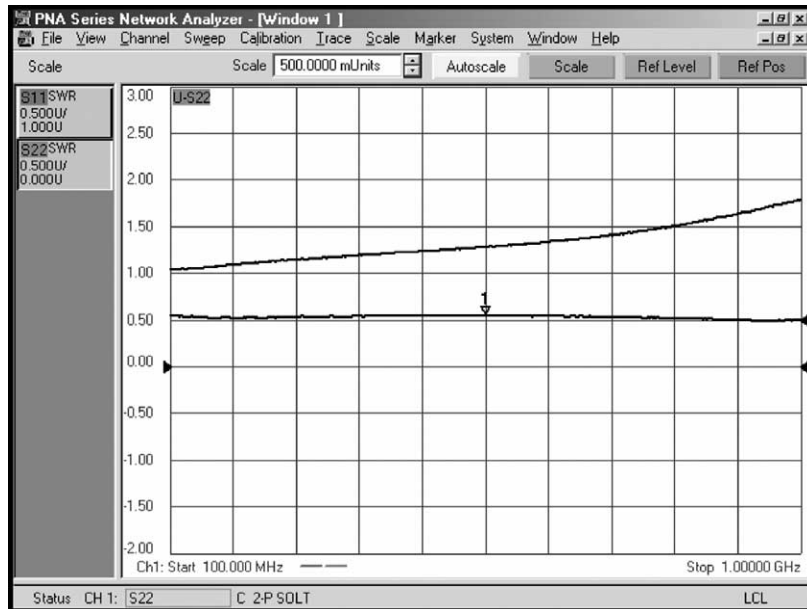

Figure 7. Measure the input and output match of an amplifier using the MW PNA.

# Gain Compression

There are two ways to measure amplifier gain compression: swept frequency gain compression and swept power gain compression.

## Swept frequency gain compression

This measurement allows the user to easily determine the frequency at which 1 dB gain compression first occurs. This is accomplished by normalizing to the small signal gain and by observing the reduction in gain as input power is increased.

## Swept power gain compression

By applying a fixed frequency power sweep to the input of an amplifier, gain compression is observed as a 1 dB drop in the gain from the small signal value. The fixed frequency chosen is often the frequency for which 1 dB compression first occurred in the swept frequency gain compression.

Gain compression can be specified in terms of both input power and output power. Since gain compression is specified at an absolute power level, absolute power accuracy is desired. With the MW PNA Series, a source power calibration (same as power meter calibration) provides input power accuracy, while a receiver calibration provides output power accuracy.

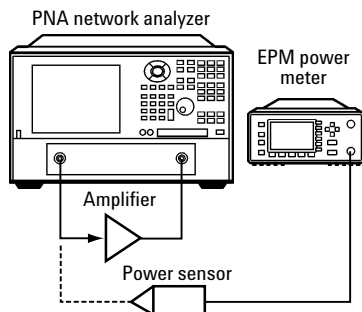

Figure 8. Setup for testing gain compression and swept-harmonic response measurements

## Step 1: Setup

In this procedure, we will take advantage of the multi-channel and multi-trace features of the MW PNA Series.

Configure the MW PNA as follows:

	Channel	Sweep type	Traces	Frequency	Source power	Calibration
<b>Swept frequency gain compression</b>	Ch 1	Frequency sweep	1 trace, S <sub>21</sub>	0.1 to 1 GHz	-20 dBm	2-port cal
<b>Swept power gain compression</b>	Ch 2	Power sweep	2 traces, S <sub>21</sub> and B	0.1 GHz	-25 to 0 dBm	2-port cal, Src Pwr Cal, Rcvr Cal

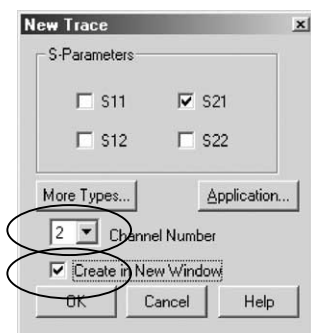

Figure 9 . Measure gain with an S<sub>21</sub> trace.

Recall the "amplifier.cst" instrument state as a starting point for channel 1.

[Recall] > ampl... cst

[Measure] > S<sub>21</sub>

Configure channel 2, using the menu item **Trace**, with two traces: an S<sub>21</sub> and a B trace. Be sure to select channel 2, as the network analyzer defaults to channel 1. A "B" receiver measurement allows you to observe the absolute output power of the amplifier. Use the menu item **Trace**, and then **More Types...** Unselect **Ratioed Type**.

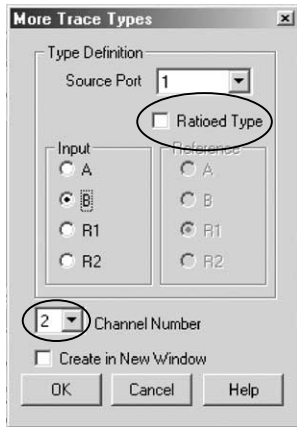

Figure 10. Measure absolute output power with a B trace.

Next configure channel 2 for a power sweep, from  $-25$  dBm to  $0$  dBm.

[Sweep Type] > Power Sweep

[Power] > Start Power >  $-25$  [Enter]

Stop Power >  $0$  [Enter]

[Start/Center] > CW Freq >  $100$  [M/ $\mu$ ]

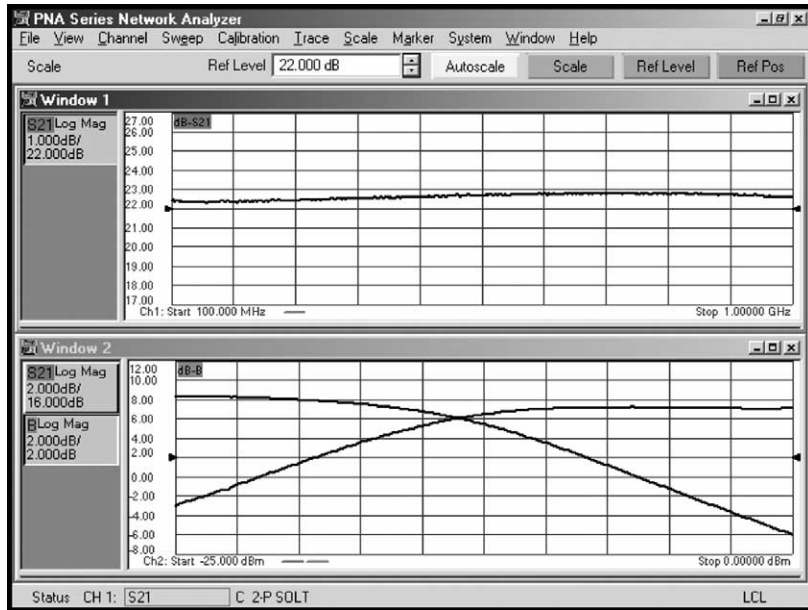

Figure 11. Configure  $S_{21}$  traces as the initial step for swept frequency gain compression (top trace), and swept power gain compression (lower traces)

Perform a quick check on the measurement before calibrating the test setup. The  $S_{21}$  trace of channel 1 should display the approximate gain of the amplifier, while the  $S_{21}$  and B traces on channel 2 should show a typical gain compression curve.

## Step 2: Calibrate

Once the setup is complete, perform a calibration on both channels. On channel 1, you can use the calibration from the first step – a two-port calibration is adequate.

On channel 2, perform three calibrations: (1) A 2-port calibration on the  $S_{21}$  trace, (2) a source power calibration on the  $S_{21}$  trace, and (3) a receiver calibration on the B trace. Perform the 2-port calibration using the ECal module.

The source power calibration functionality is located under the menu item **Calibration**.

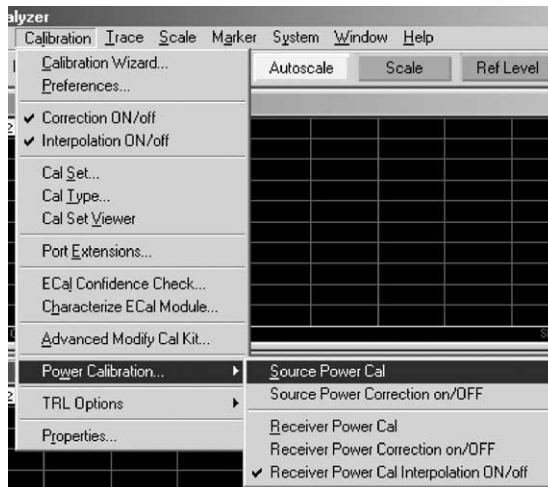

**Figure 12. Source power calibration transfers the accuracy of a power meter measurement to the MW PNA source.**

Connect an appropriate power sensor to test port 1 and then perform the calibration.

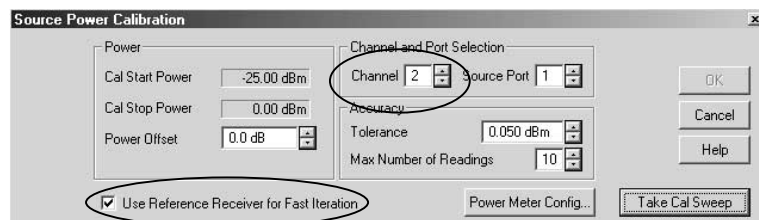

**Figure 13. A source power calibration adjusts the output power of the network analyzer for absolute power accuracy.**

Next, perform a receiver cal. A receiver cal is essentially a trace normalization, similar to a response cal. The difference between a receiver cal and a response cal is that a receiver cal is performed on the B receiver and provides absolute accuracy, whereas a response cal is performed on an  $S_{21}$  measurement and provides relative accuracy. An accurate receiver cal starts with a source power cal as the reference.

Make a through connection between port 1 and port 2 and perform the calibration

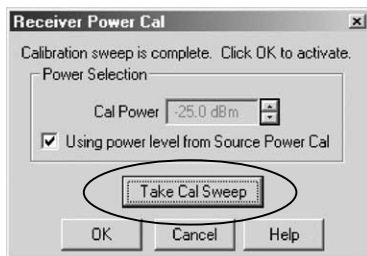

**Figure 14. A receiver calibration provides output power accuracy.**

### Step 3: Measure

Once both calibrations are complete, connect the amplifier and observe the display. Note the status bar on Figures 15 and 16. On Figure 15,  $S_{21}$  is selected and the status bar shows a "2-P SOLT" and "Src Pwr Cal". On Figure 16, B is selected and the status bar shows a "Rcvr Cal" and "Src Pwr Cal".

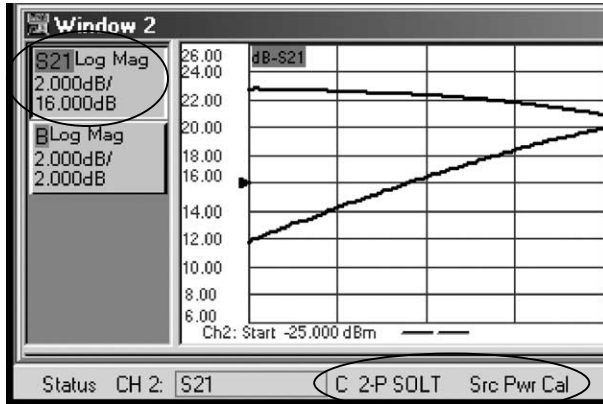

Figure 15. A 2-port cal is applied to the  $S_{21}$  trace.

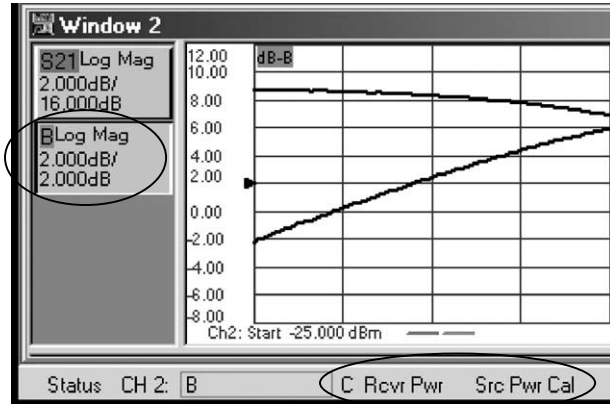

Figure 16. A Rcvr Cal is applied to the B trace.

Now that the calibrations are complete, start the gain compression measurement.

#### Channel 1: Swept frequency gain compression

Select the  $S_{21}$  trace of channel 1. Normalize the trace by using the data to memory functionality of the MW PNA.

[Math/Memory] > Data >> Memory > Data/Mem

The modified  $S_{21}$  data trace should show 0 dB gain. Next, using the rotary knob, increase the source power level until the trace drops by 1 dB at some frequency point.

[Power] > Level > Increase power using the knob

A marker can then be used to track the exact frequency where 1 dB compression first occurs. Observe the power level on the display. This is the approximate input power level for the 1 dB compression.

#### Channel 2: Swept power gain compression

Select the  $S_{21}$  trace on channel 2. Place a marker on the trace. Move the marker to the flat portion of the trace. If there is no flat portion, the amplifier is in compression throughout the sweep, and the start power level must be decreased.

[Marker] > Marker 1 > Move the marker using the knob

Use the delta marker function to find the power level for which a 1 dB drop in gain occurs. Use the coupled marker function to place a marker on the B trace and display the absolute input and output power where compression occurs.

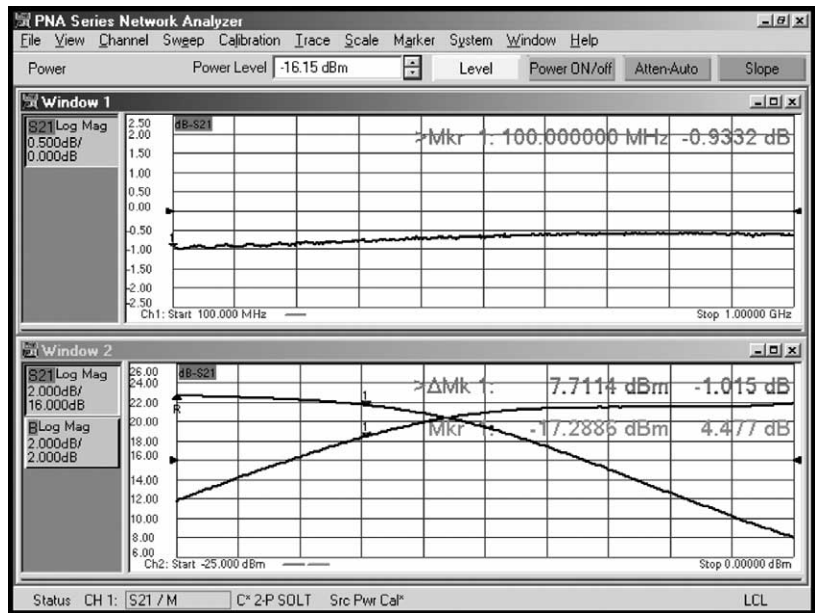

**Figure 18. Measure the 1 dB compression accurately using the MW PNA network analyzer.**

The B trace marker x-axis value (stimulus) is the input power level and the y-axis value (response) is the output power level at which the amplifier first compresses. This measurement can be repeated at multiple frequencies, if desired.

## Accuracy Considerations

### Gain

The major sources of error in a gain measurement with a network analyzer are the frequency response of the test setup, the source and load mismatch during measurement, and the system dynamic accuracy. The frequency response of the test setup is the dominant error in a transmission measurement. A simple response calibration significantly reduces this error. For greater accuracy, a full 2-port calibration can be used. Mismatch uncertainties are a function of effective source and load mismatches. A full 2-port calibration not only reduces the effects of frequency response, it also improves the effective source and load match.

Dynamic accuracy, a measure of the receiver's performance as a function of incident power level, also influences the uncertainty of gain measurements. This is because a receiver usually sees a different power level between calibration and measurement.

### Reverse isolation

Isolation is subject to the same error considerations as gain. In addition, if the isolation of the amplifier under test is very large, the transmitted signal level may be near the noise floor and/or crosstalk level. To lower the noise floor, employ averaging or reduce the IF bandwidth. To reduce crosstalk, perform an isolation calibration.

### Reflection

The uncertainty of reflection measurements is affected by directivity, source match, load match, and the reflection tracking of the test system. With a full 2-port calibration, the effects of these factors are minimized. A 1-port calibration provides the same accuracy if the output of the amplifier is well terminated, or if the amplifier's reverse isolation is considerably larger than its gain. Since the magnitude of the mismatch uncertainty depends on the input and output match of an amplifier, a measurement of a better-matched amplifier will contain less uncertainty.

### Gain compression

Swept frequency gain compression measurements employ response calibrations to reduce uncertainties. Be aware, however, that to determine swept frequency gain compression, the source power level must be changed. Therefore, the validity of the response calibration is reduced when varying source power for swept frequency measurements. Swept power gain compression measurements employ source and receiver calibration to reduce uncertainties. A source power calibration precisely sets the power level incident upon the amplifier by compensating the source power for any nonlinearities in the source or test setup.

---

## References

Microwave PNA Series Network Analyzer Application Note 1408-8,  
*Amplifier Swept Harmonic Measurements*, Literature number 5988-9473EN

Microwave PNA Series Network Analyzer Application Note 1408-9,  
*Amplifier Intermodulation-Distortion Measurements*, Literature number 5988-9474EN

## Web Resources

For additional literature and product information about the Agilent PNA Series visit:  
[www.agilent.com/find/pna](http://www.agilent.com/find/pna)

For additional information about Agilent electronic calibration (ECal) modules visit:  
[www.agilent.com/find/ecal](http://www.agilent.com/find/ecal)



## Agilent Email Updates

[www.agilent.com/find/emailupdates](http://www.agilent.com/find/emailupdates)

Get the latest information on the products and applications you select.

### Agilent Technologies' Test and Measurement Support, Services, and Assistance

Agilent Technologies aims to maximize the value you receive, while minimizing your risk and problems. We strive to ensure that you get the test and measurement capabilities you paid for and obtain the support you need. Our extensive support resources and services can help you choose the right Agilent products for your applications and apply them successfully. Every instrument and system we sell has a global warranty. Support is available for at least five years beyond the production life of the product. Two concepts underlie Agilent's overall support policy: "Our Promise" and "Your Advantage."

#### Our Promise

Our Promise means your Agilent test and measurement equipment will meet its advertised performance and functionality. When you are choosing new equipment, we will help you with product information, including realistic performance specifications and practical recommendations from experienced test engineers. When you use Agilent equipment, we can verify that it works properly, help with product operation, and provide basic measurement assistance for the use of specified capabilities, at no extra cost upon request. Many self-help tools are available.

#### Your Advantage

Your Advantage means that Agilent offers a wide range of additional expert test and measurement services, which you can purchase according to your unique technical and business needs. Solve problems efficiently and gain a competitive edge by contracting with us for calibration, extra-cost upgrades, out-of-warranty repairs, and onsite education and training, as well as design, system integration, project management, and other professional engineering services. Experienced Agilent engineers and technicians worldwide can help you maximize your productivity, optimize the return on investment of your Agilent instruments and systems, and obtain dependable measurement accuracy for the life of those products.

#### Agilent T&M Software and Connectivity

Agilent's Test and Measurement software and connectivity products, solutions and developer network allows you to take time out of connecting your instruments to your computer with tools based on PC standards, so you can focus on your tasks, not on your connections. Visit [www.agilent.com/find/connectivity](http://www.agilent.com/find/connectivity) for more information.

#### By internet, phone, or fax, get assistance with all your test & measurement needs

##### Phone or Fax

##### United States:

(tel) 800 452 4844

##### Canada:

(tel) 877 894 4414

(fax) 905 282 6495

##### China:

(tel) 800 810 0189

(fax) 800 820 2816

##### Europe:

(tel) (31 20) 547 2323

(fax) (31 20) 547 2390

##### Japan:

(tel) (81) 426 56 7832

(fax) (81) 426 56 7840

##### Korea:

(tel) (82 2) 2004 5004

(fax) (82 2) 2004 5115

##### Latin America:

(tel) (305) 269 7500

(fax) (305) 269 7599

##### Taiwan:

(tel) 0800 047 866

(fax) 0800 286 331

##### Other Asia Pacific

##### Countries:

(tel) (65) 6375 8100

(fax) (65) 6836 0252

Email:

[tm\\_asia@agilent.com](mailto:tm_asia@agilent.com)

#### Online Assistance:

[www.agilent.com/find/assist](http://www.agilent.com/find/assist)

Product specifications and descriptions in this document subject to change without notice.

© Agilent Technologies, Inc. 2003, 2004  
Printed in USA, February 4, 2004  
5988-8644EN



Agilent Technologies